

# ALKU S&S

DESIGN IIRO VILJANEN

Inspiring  
spaces

**Martela**



#### **Säädöt:**

Korkeussäätö sähköjaloilla välillä 640 -1290 mm, säätöalue 650 mm. Nostokyky 120 kg.

#### **Lisävarusteet:**

Keskusyksikköelineet, akustiset tuotteet, lisävarusteet johdoille, pöytähylyt, pöytäseinäkkeet, monitorivarret, etulevyt, lajittelijat.

#### **Materiaalikuvaus:**

Pöytien kannet E0,5 -vaatimustason täyttävää lastulevyä, joka on pinnoitettu laminaatilla tai viilutettu MDF -levy koivu-, pyökki-, tai tammiviilulla. Viilutetut pinnat on lakattu. Vakiolaminaatit ovat koivu, valkoinen sekä keskiharmaa.

Jalusta jauhemaalattu teräs, värit valkoinen, harmaa, musta, kromattu tai Inspiring Colours.

2 moottoria.

\* 120x60 cm on pienin erillinen pöytä, johon on mahdollista saada sähköjalusta.

# ALKU S&S

DESIGN IIRO VILJANEN

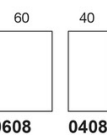
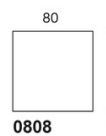
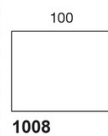
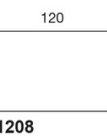
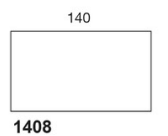
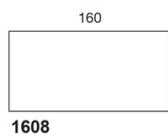
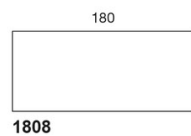
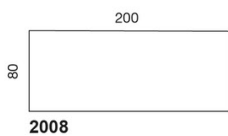
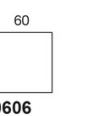
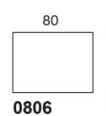
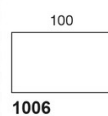
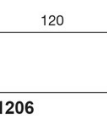
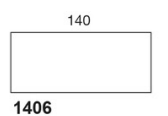
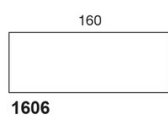
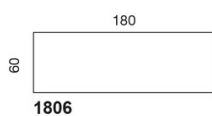
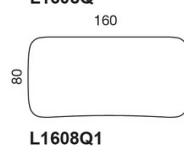
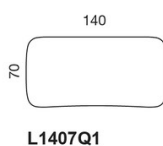
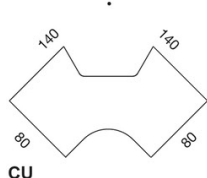
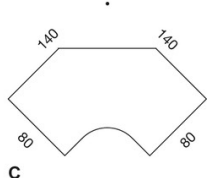
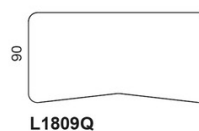
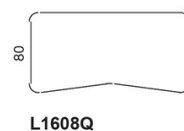
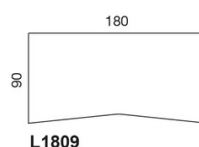
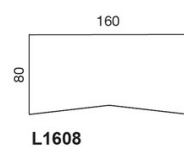
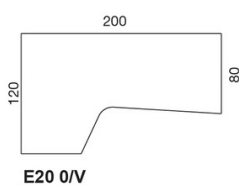
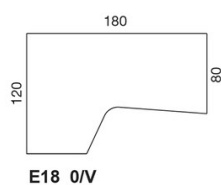
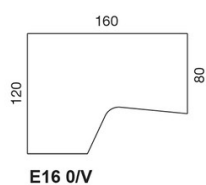
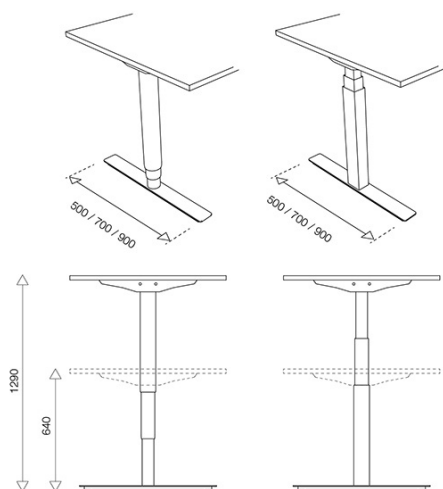

\* 100-60 x 60, 100-40 x 80 sizes are available only for extension tops

\* 100-60 x 60, 100-40 x 80 koot vain lisäkansissa

\* 100-60 x 60, 100-40 x 80 storlekar endast för extra tops